

FORMULA

Version (REV. B)

Racing Performance Catalog & Reference Guide

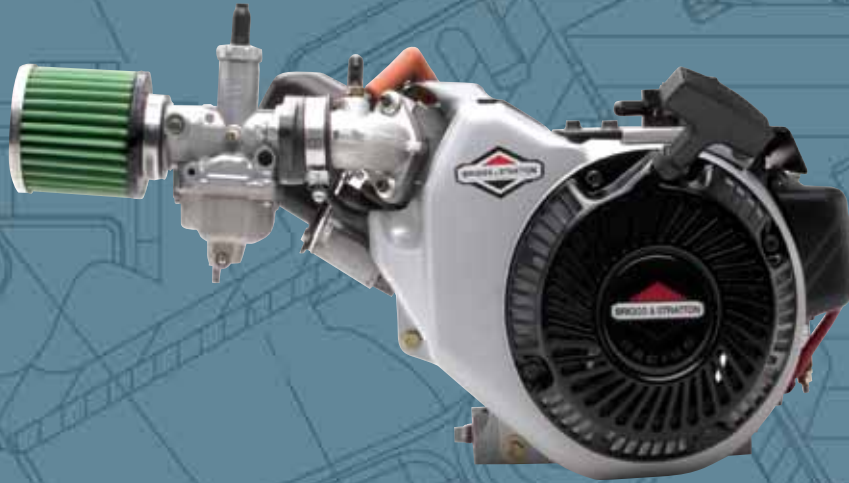

Model/Type: 124335 8105-01 (International)
124335 8104-01 (US Standard)



TABLE OF CONTENTS

SAFETY 1-2

WORLD FORMULA

General Specs 3

Special Tools..... 3

Torque Specs 3

Racing Specifics..... 3

Optional Performance Parts 3

Highlighted Features..... 3

Cylinder Assembly Parts Explode 4

Head Assembly Parts Explode 5

Housing & Flywheel Parts Explode..... 6

Carburetor Assembly Parts Explode..... 7

Clutch Assembly Parts Explode..... 8

Starter Assembly Parts Explode..... 9

Control Bracket & Gasket Sets Parts Explode 10

English	Spanish	French
en	es	fr

PZ26 Carburetor Tuning Guide 11 15 19

Electric Starting System Wiring Diagram 12 16 20

Fuel Pump Diagram..... 12 16 20

Exhaust System Diagram..... 12 16 20

Air Filter Maintenance..... 13 17 21

Engine Mounting..... 13 17 21

Oil..... 14 18 22

Engine Break-In (Running In)..... 14 18 22

Fuel 14 18 22

Maximum Recommended RPM 14 18 22

CONGRATULATIONS on your purchase of a Briggs & Stratton World Formula Racing Engine. This engine has been designed for sanctioned racing only and for use at only sanctioned tracks. It is vital for the longevity and dependability of this product that you read the following, as the initial usage of this engine will affect its life overall.

WE RECOMMEND that all modifications and setup of this engine be done by a reputable source of supply with the proper knowledge needed to work on a racing engine.



BEFORE OPERATING ENGINE

- Read entire Operating & Maintenance Instructions AND the instructions for the equipment this engine powers.*
- Failure to follow instructions could result in serious injury or death.

THESE INSTRUCTIONS CONTAIN SAFETY INFORMATION TO

- Make you aware of hazards associated with engines
- Inform you of the risk of injury associated with those hazards, and
- Tell you how to avoid or reduce the risk of injury



WARNING

The engine exhaust from this product contains chemicals known to the State of California to cause cancer, birth defects, or other reproductive harm.



WARNING

Briggs & Stratton® Engines are not designed for and are not to be used to power: fun-karts; go-karts; children's, recreational, or sport all-terrain vehicles (ATVs); motorbikes; hovercraft; aircraft products; or vehicles used in competitive events not sanctioned by Briggs & Stratton. For information about competitive racing products, see www.briggsracing.com. For use with utility and side-by-side ATVs, please contact Briggs & Stratton Engine Application Center, 1-866-927-3349. Improper engine application may result in serious injury or death.

NOTICE: This engine was shipped from Briggs & Stratton without oil. Before you start the engine, make sure you add oil according to the instructions in this manual. If you start the engine without oil, it will be damaged beyond repair and will not be covered under warranty.



WARNING

Fuel and its vapors are extremely flammable and explosive. Fire or explosion can cause severe burns or death.



When Adding Fuel

- Turn engine off and let engine cool at least 2 minutes before removing the fuel cap.
- Fill fuel tank outdoors or in well-ventilated area.
- Do not overfill fuel tank. To allow for expansion of the fuel, do not fill above the bottom of the fuel tank neck.
- Keep fuel away from sparks, open flames, pilot lights, heat, and other ignition sources.
- Check fuel lines, tank, cap, and fittings frequently for cracks or leaks. Replace if necessary.
- If fuel spills, wait until it evaporates before starting engine.

When Starting Engine

- Ensure that spark plug, muffler, fuel cap and air cleaner (if equipped) are in place and secured.
- Do not crank engine with spark plug removed.
- If engine floods, set choke (if equipped) to OPEN/RUN position, move throttle (if equipped) to FAST position and crank until engine starts.

When Operating Equipment

- Do not tip engine or equipment at angle which causes fuel to spill.
- Do not choke the carburetor to stop engine.
- Never start or run the engine with the air cleaner assembly (if equipped) or the air filter (if equipped) removed.

When Changing Oil

- When you drain the oil from the top oil fill tube, the fuel tank must be empty or fuel can leak out and result in a fire or explosion.

When Transporting Equipment

- Transport with fuel tank EMPTY or with fuel shut-off valve OFF.

When Storing Fuel Or Equipment With Fuel In Tank

- Store away from furnaces, stoves, water heaters or other appliances that have pilot lights or other ignition sources because they can ignite fuel vapors.

OPERATOR SAFETY

SAFETY AND CONTROL SYMBOLS



The safety alert symbol  is used to identify safety information about hazards that can result in personal injury. A signal word (DANGER, WARNING, or CAUTION) is used with the alert symbol to indicate the likelihood and the potential severity of injury. In addition, a hazard symbol may be used to represent the type of hazard.

 **DANGER** indicates a hazard which, if not avoided, will result in death or serious injury.

 **WARNING** indicates a hazard which, if not avoided, could result in death or serious injury.

 **CAUTION** indicates a hazard which, if not avoided, could result in minor or moderate injury.

NOTICE indicates a situation that could result in damage to the product.



WARNING

Certain components in this product and its related accessories contain chemicals known to the State of California to cause cancer, birth defects, or other reproductive harm. Wash hands after handling.

*Briggs & Stratton does not necessarily know what equipment this engine will power. For that reason, you should carefully read and understand the operating instructions for the equipment on which your engine is placed.

**WARNING**

Starting engine creates sparking.
Sparking can ignite nearby flammable gases.
Explosion and fire could result.



- If there is natural or LP gas leakage in area, do not start engine.
- Do not use pressurized starting fluids because vapors are flammable.

**WARNING**

Engines give off carbon monoxide, an odorless, colorless, poison gas.
Breathing carbon monoxide can cause nausea, fainting or death.

- Start and run engine outdoors.
- Do not start or run engine in enclosed area, even if doors or windows are open.

**WARNING**

Rapid retraction of starter cord (kickback) will pull hand and arm toward engine faster than you can let go.
Broken bones, fractures, bruises or sprains could result.

- When starting engine, pull the starter cord slowly until resistance is felt and then pull rapidly to avoid kickback.
- Remove all external equipment/engine loads before starting engine.
- Direct-coupled equipment components such as, but not limited to, blades, impellers, pulleys, sprockets, etc., must be securely attached.

**WARNING**

Rotating parts can contact or entangle hands, feet, hair, clothing, or accessories.
Traumatic amputation or severe laceration can result.

- Operate equipment with guards in place.
- Keep hands and feet away from rotating parts.
- Tie up long hair and remove jewelry.
- Do not wear loose-fitting clothing, dangling drawstrings or items that could become caught.

**WARNING**

Running engines produce heat. Engine parts, especially muffler, become extremely hot.



Severe thermal burns can occur on contact.

Combustible debris, such as leaves, grass, brush, etc. can catch fire.

- Allow muffler, engine cylinder and fins to cool before touching.
- Remove accumulated debris from muffler area and cylinder area.
- It is a violation of California Public Resource Code, Section 4442, to use or operate the engine on any forest-covered, brush-covered, or grass-covered land unless the exhaust system is equipped with a spark arrester, as defined in Section 4442, maintained in effective working order. Other states or federal jurisdictions may have similar laws. Contact the original equipment manufacturer, retailer, or dealer to obtain a spark arrester designed for the exhaust system installed on this engine.

**WARNING**

Unintentional sparking can result in fire or electric shock.



Unintentional start-up can result in entanglement, traumatic amputation, or laceration.



Fire hazard

**Before performing adjustments or repairs:**

- Disconnect the spark plug wire and keep it away from the spark plug.
- Disconnect battery at negative terminal (only engines with electric start).
- Use only correct tools.
- Do not tamper with governor spring, links or other parts to increase engine speed.
- Replacement parts must be of the same design and installed in the same position as the original parts. Other parts may not perform as well, may damage the unit, and may result in injury.
- Do not strike the flywheel with a hammer or hard object because the flywheel may later shatter during operation.

When testing for spark:

- Use approved spark plug tester.
- Do not check for spark with spark plug removed.

WORLD FORMULA

GENERAL SPECS

Model: 124335
Type: 8104/8105
Displacement:
 12.48 Cu. in. - 205 cc
Design: Slant, 30 degree,
 Overhead Valve, Electric Start
Bore: 2.6875/2.6885 in. (68.3mm)
Stroke: 2.2 in. (55.9mm)
Compression Ratio: 9.5 to 1
Factory Timing: 29 degrees BTDC

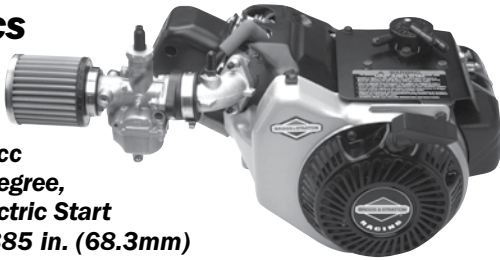

SPECIAL TOOL REQUIREMENTS

General Model 12 Manual Part No. 276781
PVL™ Flywheel Puller Part No. 19584
Flywheel Wrench Part No. 19433

TORQUE SPECS

DESCRIPTION	WRENCH/SOCKET SIZE	TORQUE
Air Guard	7mm	40-50 lb-in. (4.5-5.6 Nm)
Blower Housing	10mm & 3/8"	60-110 lb-in. (7-12.5 Nm)
Carburetor (to manifold)	10mm	80-110 lb-in. (9-12.4 Nm)
Connecting Rod	T27	140-150 lb-in. (16-17 Nm)
Cylinder Head Bolts	10mm	200-220 lb-in. (20-27 Nm)
Exhaust Brace Screws	10mm	95-125 lb-in. (11-14 Nm)
Exhaust Stud	10mm	95-125 lb-in. (11-14 Nm)
Flywheel Nut	15/16	55-75 ft-lbs. (74.5-101 Nm)
Flywheel Fan	10mm	180-240 lb-in. (20-27 Nm)
Intake (to cylinder)	5mm Allen	70-90 lb-in. (8-10.2 Nm)
Oil Drain Plug	3/8"	100-125 lb-in. (11-14 Nm)
PVL™ Module	7mm	20-35 lb-in. (2.3-4 Nm)
Rocker Arm Stud	US-7/16", metric-10mm	90-120 lb-in. (10-14 Nm)
Rocker Arm Plate	10mm	70-90 lb-in. (7.9-10.1 Nm)
Rocker Arm Set Screw	US-1/8" Allen, metric-4mm	50-70 lb-in (5.6-7.9 Nm)
Spark Plug	5/8" Deep	95-145 lb-in. (11-16.4 Nm)
Side Cover	10mm	95-125 lb-in. (11-14 Nm)
Starter Gear	#2 Phillips	35-53 lb-in. (4-6 Nm)
Top Control Plate	10mm	70-90 lb-in. (8-10 Nm)
Valve Cover	10mm Lower & 3/8"	30-60 lb-in. (3.5-7 Nm)

RACING SPECIFICS

PVL™ Ignition Module Gap - .010/.014 (.15/.36mm)
Digital Rev Limiter - 7,100 RPM +/- 50
Spark Plug - Champion™ RG4HC
Fuel Requirements - 98 Octane (RON)
Recommended Oil Capacity - 14-16 oz. of Briggs & Stratton Synthetic 4T Racing Oil custom blended by Amsoil. This oil is available through your current Briggs & Stratton or Amsoil source of supply. The use of 'karting' oils or automotive oils (use only during initial break-in) are no longer recommended due to their severe limitations that could impact the life of your engine.
Exhaust System Requirements-50mm x 57mm Flex Coupling, 50/90 Canister Muffler.
Starter System-12 Volts @ 20 Amp Capacity-180 Cold Cranking amps. Refer to your sanctioning body rules for required installation location.

HIGHLIGHTED FEATURES

- Dual Ball-Bearing, RACING Reinforced Cylinder
- Billet Rod
- Slotted, Stelite-Faced, Ground Cam w/ Compression Release
- Dual, High-Silicon Valve Springs
- PVL™ Digital Ignition System w/ 7,100 RPM Limiter
- CNC D-Shape Intake Port
- Walbro™ Round-Slide Carburetor
- Dana™ Fire-Ring Head Gasket
- Racing Crankshaft w/ Induction-Hardened Crankpin
- Green™ Air Filter
- Federal Mogul™ Moly-Coated Cam Ground, Barrel-Faced Piston
- Chrome-Faced, Racing Only Ring Package
- Port-Liner, Exhaust System
- Mikuni™ Fuel Pump
- Noram™ Clutch w/ Quick Change Sprocket Set
- Automotive 3-Piece Valve Retainer System
- Beefy Rocker Arm Stud Nuts



NO COMPROMISES.

At the end of the day the effort you put into racing directly determines your outcome. You wouldn't compromise on your approach to racing, so why would you with your oil? What if there was an oil engineered specifically for high-revving, air-cooled racing engines, methanol or gas fuels, that gives you the power of a lite oil yet the wear protection of a heavy oil? What if that oil also had the added benefits of wear protection and a corrosion inhibitor to safeguard your investment during, between, and after the season was over?

COMPROMISES LEAD TO WHAT-IF'S AND AS RACERS THAT ISN'T PART OF OUR DNA. NO MORE COMPROMISES.

INTRODUCING THE BRIGGS & STRATTON 4T FULL SYNTHETIC OIL CUSTOM ENGINEERED BY AMSOIL.

- MAXIMUM HORSEPOWER
- OUTSTANDING WEAR PROTECTION
- EXCLUSIVE SYNTHETIC FORMULATION
- EXHAUSTIVELY TESTED ON THE DYNO AND ON THE TRACK
- DESIGNED FOR HIGH REVVING, AIR-COOLED RACING ENGINES

Briggs & Stratton 4T Racing Oil is available through any authorized Briggs & Stratton Racing dealer. For additional information or to locate a dealer near you please visit www.briggsracing.com.



Part Number: 662960

OPTIONAL PERFORMANCE PARTS

- High - G/Force Breather Bypass System - Part No. 555688**
- Magnetic Drain Plug - Part No. 691663**
- Gearbox Splined Crankshaft - Part No. 555722**
- 6-1 Gearbox Complete - Part No. 555721**
- Electric Starter Kit - Part No. 555703**
- Fuel Filter - Part No. 394358B**

- 557121 Piston Assembly
(Std., with File to fit Top Ring)
- 557122 Piston Assembly
(.10" Over, with File to fit Top Ring)
- 557123 Piston Assembly
(.20" Over, with File to fit Top Ring)
- 557124 Piston Assembly
(.30" Over, with File to fit Top Ring)

- 555664 Ring Set ●
(Std.)
- 555665 Ring Set ●
(.10" Over)
- 555666 Ring Set ●
(.20" Over)
- 555667 Ring Set ●
(.30" Over)

- 555692 Ring Set
(.010" Over Compression Ring)
- 555693 Ring Set
(.020" Over Compression Rings)
- 555694 Ring Set
(.030" Over Compression Ring)

- 55513 Ring Set
(.10" Over - Contains 10 Top Rings)
- 55514 Ring Set
(.20" Over - Contains 10 Top Rings)
- 55515 Ring Set
(.30" Over - Contains 10 Top Rings)

555688 Breather Assembly
(Optional, Also includes 691890 Rocker Cover Gasket)

555140 Bushing/Seal Kit
692600 Breather Tube

792723 Flywheel Nut†
299819s Oil Seal
(Magneto Side)

555680 Cylinder Shield

699483 Metric Screw
(Cylinder Shield)

699485 Crankcase Gasket•

557137 Crankshaft

691664 Screw
(Connecting Rod)

557117 Connecting Rod

691686 Oil Drain Plug*
691663 Oil Drain Plug
(Magnetic, Optional)

555705 Cylinder Assembly
690959 Locating Pin*

695087 Timing Gear†

798538 Ball Bearing•

281658S Oil Fill Cap•

690824 Ball Bearing†

222698S Flywheel Key

557117 Connecting Rod

499423 Piston Pin

691866 Piston Pin Lock ●

690979 Timing Key† (0.370")
798972 Timing Key† (0.491")

557041 Camshaft

555652 Crankshaft Endplay Shim
(Contains (4) .005, (1) .015)

281658s Oil Fill Cap•

692550 Oil Seal•
(PTO Side)

555706 Crankcase Cover

799318 Screw
(Crankcase Cover/Sump - M7x1)

*Included with 555705 Cylinder Assembly
(Includes all parts shown)

● Included with Respective Piston Assembly
(Includes all parts shown)

† Included with 557137 Crankshaft

● Included with 499423 Piston Pin

• Included with 555706 Crankcase Cover

WORLD FORMULA head assembly

(Engine Model Series 124335)

BRIGGS & STRATTON

RACING

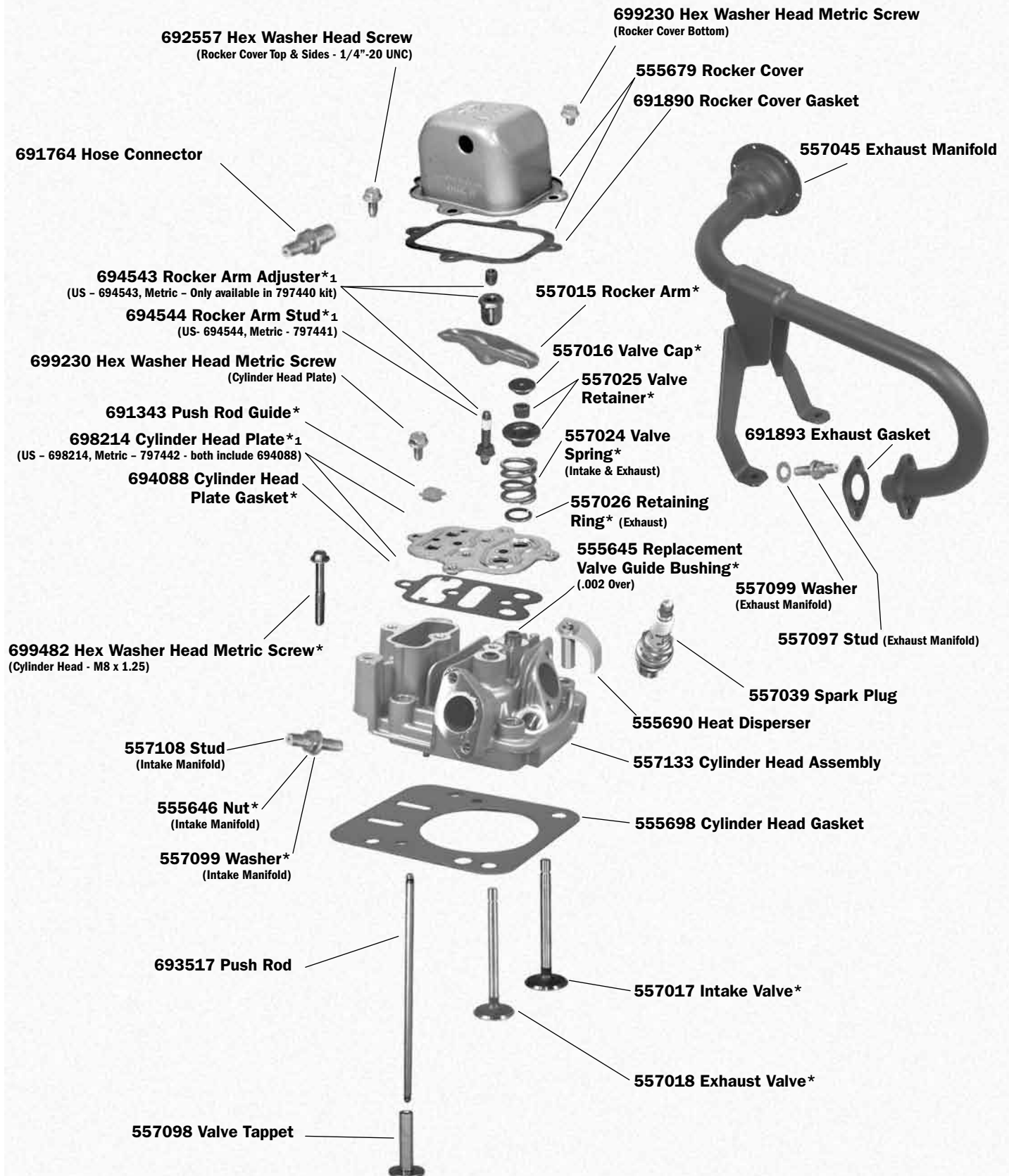

***Included with 557133 Cylinder Head Assembly**

1 - Note Metric and US standard rocker arm systems are not interchangeable.

WORLD FORMULA ENGINES

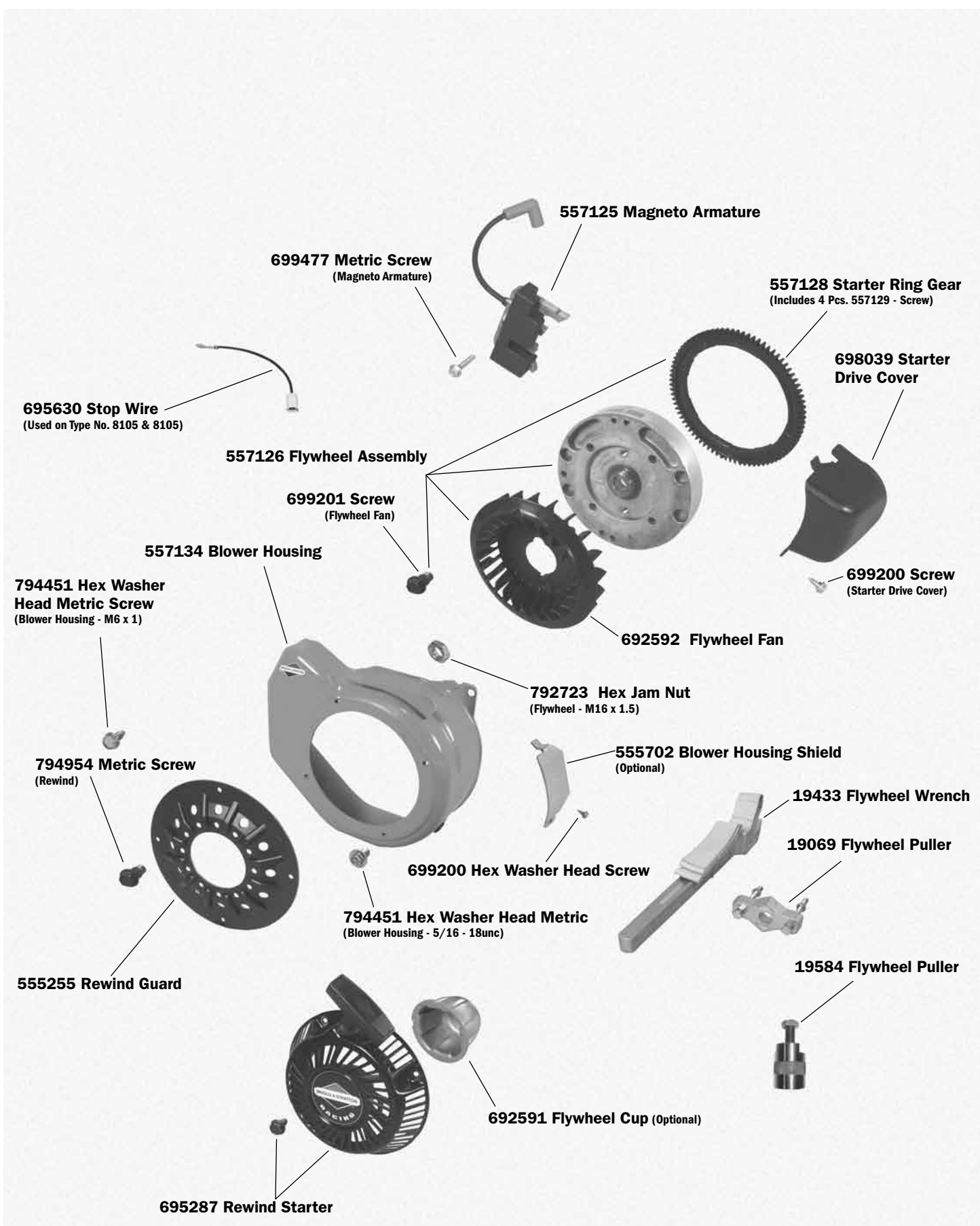

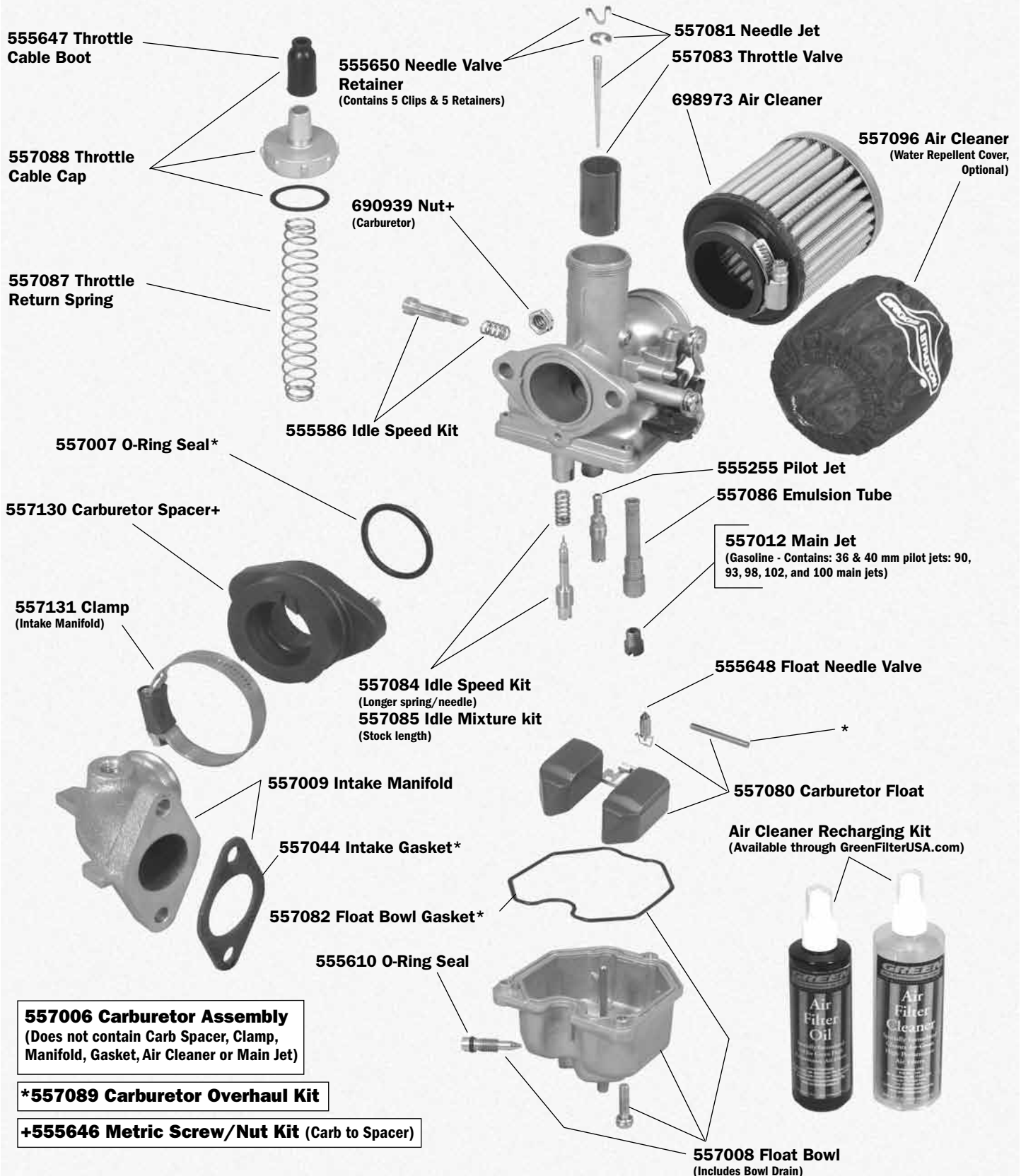

WORLD FORMULA ENGINES

557023 Centrifugal Clutch Assembly
(Does not contain Radius Washer 2400025)

557115 Snap Ring

557116 Cartridge Springs Kit
(Includes 3 Orange & 3 Yellow)

557114 Clutch Cartridge
(Includes Orange Springs)

557111 Clutch Drum

557112 Clutch Hub Shaft

557115 Snap Ring

557113 Clutch Thrust Spacer/Bearing

557019 Mounting Hardware

Noram Part Number
2400025 Radius Washer
(Required for inboard mounting,
included with Clutch Assembly)

557020 Clutch Gear (17T, #219)
557021 Clutch Gear (16T, #219)
557092 Clutch Gear (19T, #219)
557091 Clutch Gear (18T, #219)

***Included with 557068 Starter Assembly**

+Included with 691293 Brush Retainer

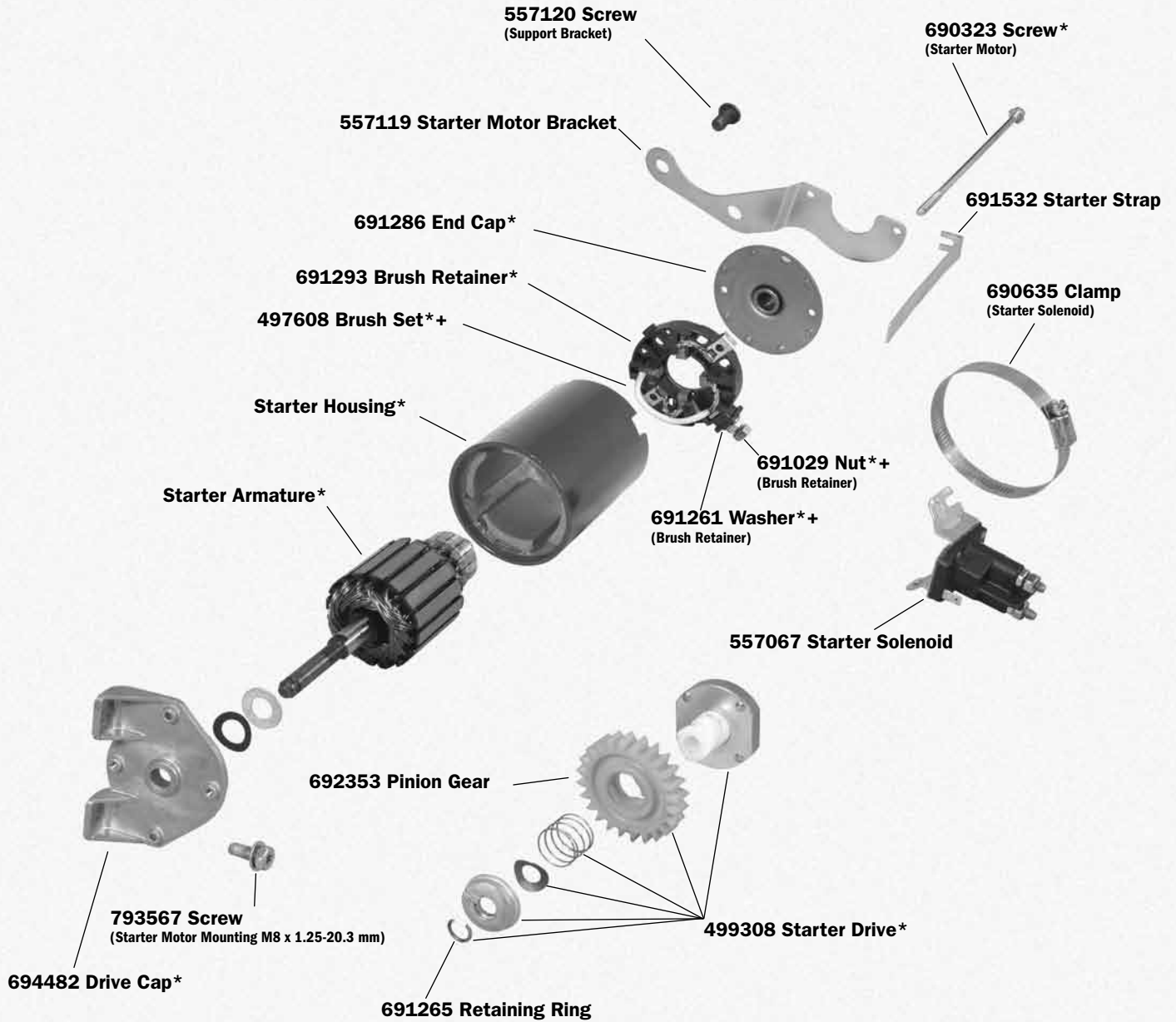

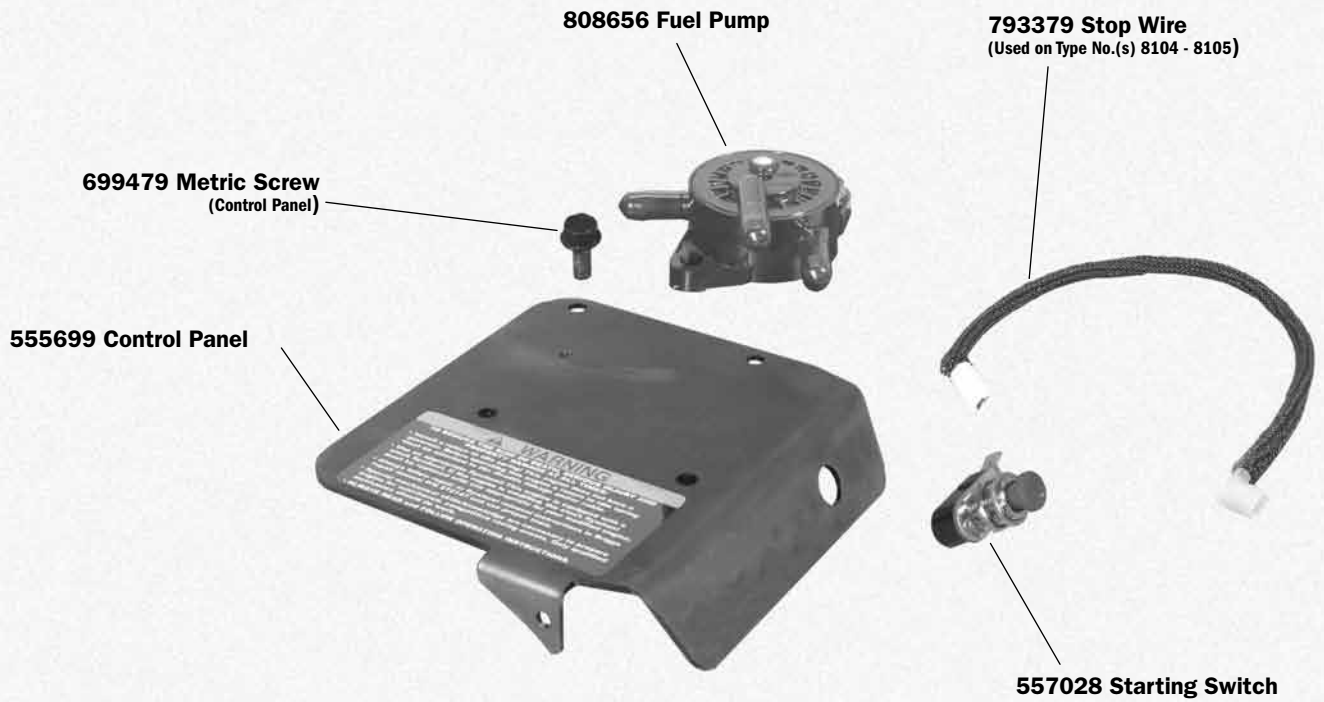

***Included with 557110 Engine Gasket Set**

+ Included with 557027 Valve Gasket Set

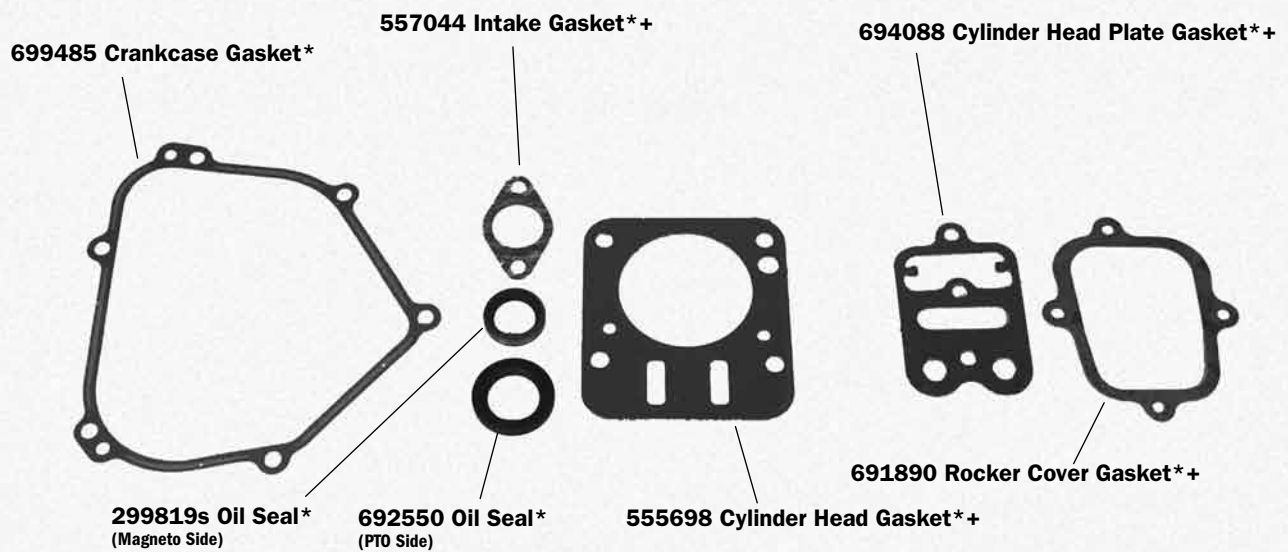

PZ26 CARBURETOR TUNING GUIDE

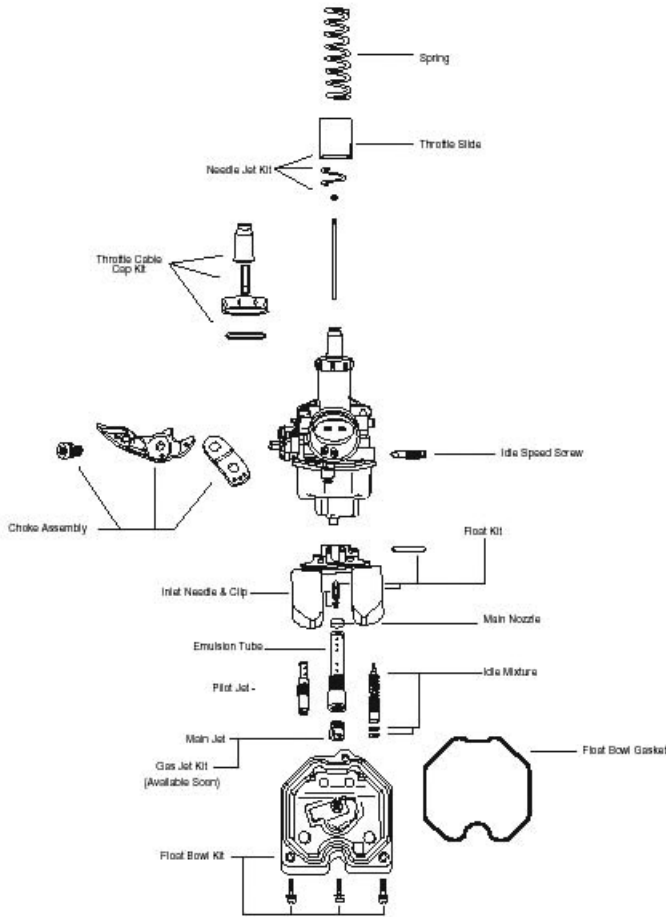

Walbro PZ Carburetor

The Walbro PZ 26 has been specifically calibrated for this application. The following guide should help you with set-up and maintenance. Replacement components are available through your authorized source of supply. An additional jet kit is also available at 557012. This kit was specifically designed to cover the majority of your gasoline jetting requirements.

Float Height

The float height controls the fuel level in the float bowl, which can also effect carburetor performance. Set float height according to specification before any other tuning. The float height may need to be adjusted for best performance on different track types.

Idle / Low Speed

Tuning of the engine at idle and low speeds is accomplished by adjusting the Idle Mixture Screw or changing the size of the Pilot Jet (also called Slow Jet). The jet size or diameter in millimeters is stamped on the jet (37 = .37mm orifice). The Idle Mixture Screw is a fuel adjustment, so closing the screw or turning it clockwise will lean the fuel mixture, and opening the screw or turning it counterclockwise will richen the fuel mixture.

To adjust the Idle Mixture Screw proceed as follows. Turn the Idle Mixture screw in until it lightly seats or stops. Back the screw out the specified number of turns. Warm the engine and set the Idle Speed screw slightly higher than the desired idle rpm. Turn the Idle Mixture screw in or out to obtain the highest rpm. Turn the Idle Speed screw to the desired idle rpm. A slightly rich idle mixture is usually better for acceleration.

If a smooth idle cannot be obtained with the Idle Mixture screw between 1/4 - 2 turns out from closed, a different size Pilot Jet may be needed. The proper size Pilot Jet will allow for smooth acceleration from an idle and steady engine speed up to 1/4 throttle opening.

Midrange / Part Throttle

The Jet Needle primarily controls fuel flow between 1/4 and 3/4 throttle opening. The Jet Needle has five notches and a C-clip on the top of it. To richen the part throttle operation, move the clip to the next lower notch. This will hold the needle farther out of the nozzle. To lean the part throttle operation, move the clip to the next higher position. The highest notch (farthest from the narrow tip) is considered the 1st position. Needle taper reference letters are stamped on the needle for identification.

High Speed / Full Throttle

The Main Jet controls the fuel flow at throttle positions of 1/2 to full throttle. The jet size or diameter in millimeters is stamped on the jet. Altitude and weather conditions can effect the engine operation enough to require changing the size of the Main Jet. High air temperature, humidity, or altitude could require a smaller Main Jet. Low temperature, humidity, or altitude would require a larger diameter Main Jet. Running the engine with an improper Main Jet could result in a loss of power, high engine temperatures, or engine damage.

Starting

This carburetor is equipped with a choke valve for starting. When the engine is cold, lift choke lever to start engine. As engine warms push choke lever down to open choke for normal operation.

CAUTION: After connecting the throttle cable to the throttle slide valve or after EVERY TIME the throttle slide is removed, always remove air filter and visually check that the throttle slide closes fully and moves freely in the bore.

GASOLINE PZ CARBURETOR GENERAL SPECIFICATIONS	
Main Jet	#96
Pilot Jet	(Slow Jet) #37
Jet Needle	CDB 4th notch
Main Nozzle Diameter	2.6 mm
Idle Mixture Screw turns out	1-1/2
Float Height*	14.0 mm

TORQUE SPECIFICATIONS	
Bowl Screws	17 - 20 in-lbs
Pilot Jet	9 - 12 in-lbs
Needle Jet	14 - 16 in-lbs
Main Jet	9 - 11 in-lbs

ELECTRICAL SCHEMATIC

This system is designed for a 12-volt power supply. For most racing applications, a high-quality, gel cell battery (determined by your authorized sanctioning body) with at least an 8-amp hour rating is recommended. An 8mm positive battery cable is required between the battery and starter solenoid. Holding down the starting switch, Part #557028, will turn the ignition OFF, and is located on the control panel, Part #555699.

See starter wiring schematic for starter switch and battery cable connections.

Warning – To avoid possibility of damage to your engines digital ignition module **COMPLETELY DISCONNECT** both the positive and negative leads to isolate the battery for charging. Follow all charging manufacturer recommendations.

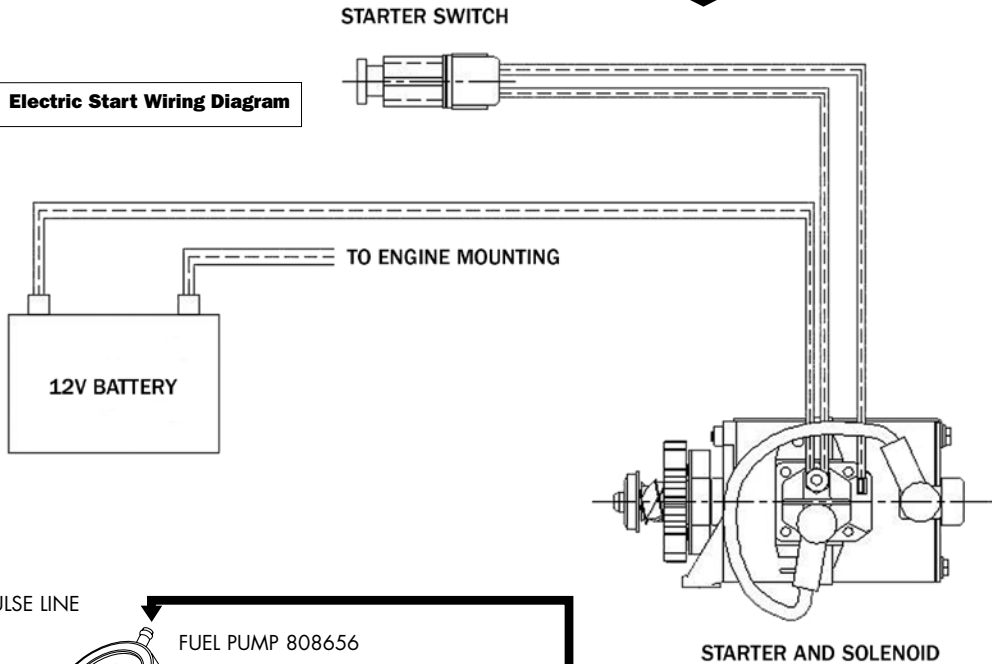

FUEL PUMP

The following diagram shows the recommended layout for attaching the fuel pump to your World Formula racing engine. A Mikuni fuel pump is supplied. The fuel pump should be installed as recommended by your local CIK organization. We recommend that this fuel pump be placed in a location that isn't affected by heat. The pulse line is marked with a "P" on the fuel pump. This should be connected with a non-collapsible fuel line (specifically made for fuel applications) to the fitting on the top of the intake manifold. The other two fittings on the fuel pump have arrows to show the inlet and outlet of the pump. Please refer to the accompanying diagram.

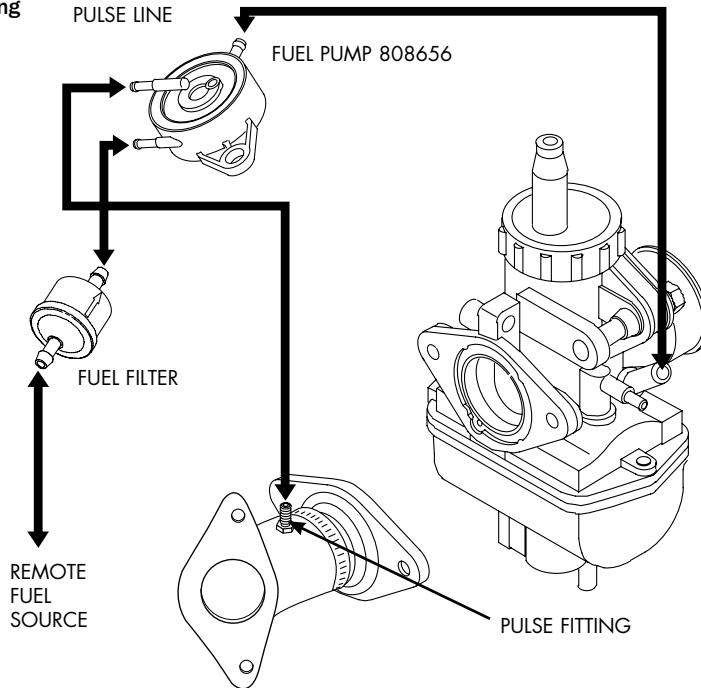

CAUTION: WE HIGHLY RECOMMEND THAT YOU USE A 75 MICRON FUEL FILTER. THIS SHOULD BE PLACED IN-LINE BETWEEN THE TANK AND THE FUEL PUMP.

EXHAUST SYSTEM

The header pipe has been tuned and designed to be run with the following parts:

- A) 50 mm diameter x 57 mm length flex coupling (not included)
- B) CIK approved 50/90 "2-stroke" muffler (not provided)
- C) Three (3) exhaust springs (not provided)

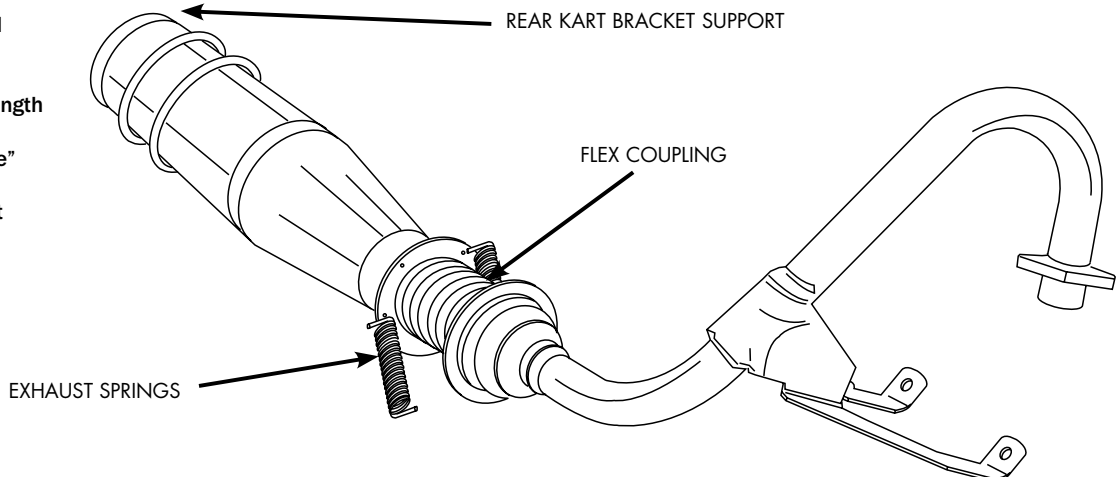

GREEN AIR FILTER

- There is a difference in technology with a standard paper air filter and your new Green High Performance Air Filter.
- Paper filters stop dirt by being made up of small holes which allow the air to pass but not the dirt. Unfortunately this is very restrictive to your engine. After each particle of dirt is stopped the filter becomes that much more restrictive, until air flow is halted to almost nothing, starving your engine of air. This drastically decreases your engine's performance.
- For best performance it is recommended your Green Filter be cleaned and oiled between each race.
- Green Filter is made of woven cotton that **MUST** be oiled. A Green Filter stops dirt differently than a paper air filter. Green High Performance Air Filters are designed to be oiled. The oil creates a positive (+) magnetic charge with the stainless steel mesh, which attracts the negatively (-) charged dust particles. The dust and dirt builds around the mesh to form a tunnel. This allows the cotton to remain cleaner for maximum air flow, but still stops the dirt. That is why it is important to keep your Green Air Filter properly oiled.
- Your Green Filter comes pre-oiled from the factory, but after each 5-10 hours of racing the filter should be checked for clogging and re-oiled. (This is based on normal race conditions. If racing is on a dirt track or in dirty conditions the filter must be cleaned more frequently. Extreme cases clean every 1-2 hrs. of race time).

Cleaning instructions:

1. Remove as much dirt from the filter as possible by tapping it on a hard surface.
 2. Using the Green Filter Cleaning & Re-Oil Kit (Part #2000), spray the filter with Green Filter cleaner. Allow the solution to soak into the filter for about 15 minutes. Or dilute the cleaner in a bucket of water and soak the filter.
 3. **CAUTION:** Never use strong detergents, high pressure water, or gasoline.
 4. Rinse the filter with warm water, inside first and then outside. (Let the water run from the clean side to the dirty side.)
 5. Allow the filter to dry completely. It is best to allow the filter to dry naturally. Don't use heat, this might shrink the Cotton.
 6. Re-oil the filter using Green Filter oil **ONLY** (kit #2000). Don't use other cotton filter oils, the color is different (Green oil is colored green and is specially formulated for Green Filters).
- * You will know when the filter is correctly oiled by the cotton changing from white to Green. (It will look wet.)
- * **CAUTION: Be sure not to over oil your filter, which can damage your sensors and engine.**

Allow filter to dry for ½ hour. If you place your Green Filter on a piece of cardboard for 10 minutes and it leaves oil stains, you have over oiled your filter. Clean and start over.



WARNING: Never use motor oil, transmission fluid, WD 40. Failure to follow instructions can cause fires resulting in death, bodily injury or property damage.

The Green Filter cleaning and re-oil kit is Part #2000. For more information and/or questions, please visit www.greenfilterusa.com.

ENGINE MOUNTING

This engine is designed to be mounted **FLAT** on the kart. Because of the carburetor setup and oiling system, we **DO NOT** recommend mounting the engine with any degree of angle.

 **OIL**

Oil is the lifeline of any engine and using a high quality oil is a must.

We recommend using 14-16 oz. of Briggs & Stratton Synthetic 4t Racing Oil custom blended by Amsoil. This oil is available through your current Briggs & Stratton or AMSOIL Source of supply. The use of 'karting' and/or standard automotive oils (beyond break-in) is NOT recommended due to their severe limitations and potential to adversely impact the life of your engines.

Note: For your engine break-in period use ONLY a high-grade SAE rated, non-synthetic 30 weight oil. The use of synthetic oil during this process could prevent proper 'seating' of the piston rings, etc..

ENGINE BREAK-IN (RUNNING IN)

The first 30 minutes of this engine's life are the most important to ensure trouble-free racing. After mounting to the kart, we recommend that the engine be broken in using any high grade non-synthetic SAE-rated 30 weight oil. Run the engine, no load, at idle (1,700-2,000 rpm) to allow the engine to reach normal operating temperature (5-8 minutes). Shut the engine off and allow to return to room temperature.

Again start up the engine and bring up to temperature (5-8 minutes). Shut off engine and change the oil. Replace the oil (16-18 ounces) and it is time to place 'load' on the engine. To apply a load on the engine the easiest way to do this is to run the engine on the track. Running not higher than 6,000 rpm, take several laps (depending on course length). With the oil still warm drain and replace the oil. Repeat and slowly begin to bring the engine up to speed.

 **FUEL**

This engine was designed for 98 Octane (RON) or 93 Octane (RON+MON/2) pump gas. The use of lower octane fuels could cause engine detonation and/or adversely affect your engine's life.

MAXIMUM RECOMMENDED RPM

Your engine has been equipped with a governor system that will limit the RPM of this engine to around 7,100 RPM + 50 RPM. This does not take away from the need to have a return to idle mechanism. Removal or tampering of this system could lead to reduced engine life, and/or serious injury, possibly even death. Also, we do not recommend repetitive use of the rev limiter as a limiting factor of RPM. This rev limiter works by actively 'shorting' the ignition system of your engine. In repetitive situations fuel loading as well as increased internal stress load of the engine can occur, greatly reducing engine life.

IGNITION MODULE/REV LIMITER – PART #557125 **WARNING**

Do not disconnect or modify the installed rev limiter. Engine overspeeding can result in flywheel failure or part failure, causing death, serious injury or property damage.

CARBURADOR WALBRO PZ

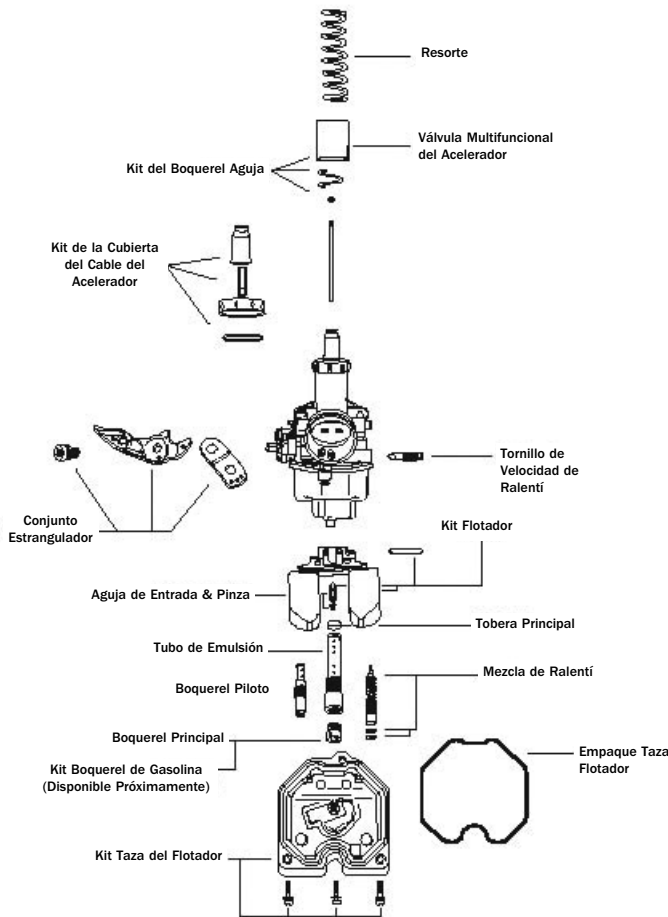

CARBURADOR WALBRO PZ

El Walbro PZ 26 ha sido específicamente calibrado para esta aplicación. La siguiente guía lo ayudará en el ajuste y el mantenimiento. Los componentes de repuesto están disponibles a través de su distribuidor autorizado. Se dispone de un kit adicional de boquerel en el kit #557012 - Este kit fue específicamente diseñado para cubrir la mayoría de los requerimientos de los boquerles de gasolina.

Altura del Flotador

La altura del flotador controla el nivel de combustible en la taza del flotador, lo cual puede afectar también del desempeño del carburador. Ajuste la altura del flotador de acuerdo a la especificación antes de hacer cualquier otro ajuste.

Ralentí / Baja Velocidad

La afinación del motor para velocidad de ralentí y velocidades mínimas viene acompañada por el ajuste del Tornillo de Mezcla de Ralentí o por el cambio del tamaño del Boquerel Piloto (conocido también como el Boquerel de Baja Velocidad). El tamaño del boquerel o el diámetro en milímetros viene grabado en el boquerel (38 = orificio de .38mm). El Tornillo de Mezcla de Ralentí es un ajuste de combustible, de manera que si se cierra el tornillo o se gira en sentido de las agujas del reloj se empobrecerá la mezcla de combustible, y si se abre el tornillo o se gira en sentido contrario al de las agujas del reloj se enriquecerá la mezcla de combustible. Para ajustar el Tornillo de Mezcla de Ralentí proceda como se indica a continuación. Gire el Tornillo de Mezcla de Ralentí hacia

adentro hasta que este ligeramente se asiente o se detenga. Devuelva el Tornillo hacia fuera el número de giros especificados. Caliente el motor y ajuste el Tornillo de Mezcla de Ralentí hacia adentro o hacia fuera para obtener las rpm más altas. Gire el Tornillo de Mezcla de Ralentí a las rpm de ralentí deseadas. Una mezcla de ralentí ligeramente rica es usualmente mejor para la aceleración.

Si no se puede obtener una velocidad de ralentí uniforme con el Tornillo de Mezcla de Ralentí entre 1/4 - 2 giros hacia afuera desde la posición cerrado, puede requerirse un Boquerel Piloto de diferente tamaño. El Boquerel Piloto del tamaño adecuado le permitirá una aceleración suave desde una velocidad constante y de ralentí con una abertura de 1/4 del acelerador.

Rango Medio / Aceleración Parcial

La aguja del boquerel controla principalmente el flujo de combustible entre 1/4 y 3/4 de abertura del acelerador. La aguja del boquerel tiene cinco muescas y una pinza en C en la parte superior de esta. Para enriquecer la operación parcial del acelerador, mueva el clip a la siguiente muesca que se encuentra más abajo. Esto sostendrá la aguja que se encuentra más lejos a distancia de la tobera. Para empobrecer la operación parcial del acelerador, mueva el clip hacia la siguiente posición más alta. La muesca más alta (la que se encuentra más lejos de la punta) es considerada como la 1a. posición. Las letras de referencia del ahusamiento de la aguja vienen grabadas en la aguja para su identificación.

Alta Velocidad / Aceleración Total

El boquerel principal controla el flujo de combustible en las posiciones de 1/2 acelerador y aceleración total. El tamaño del boquerel o el diámetro en milímetros viene grabado en el boquerel. La altitud y las condiciones climáticas pueden afectar la operación del motor lo suficiente para requerir el cambio del tamaño del Boquerel Principal. La alta temperatura del aire, la humedad, o la altitud podrían requerir un Boquerel Principal más pequeño. La baja temperatura, la humedad, o la altitud podrían requerir un Boquerel Principal con un diámetro más grande.

ARRANQUE

Este carburador está equipado con una válvula de estrangulador para el arranque. Cuando el motor esté frío, levante la válvula del estrangulador para dar arranque al motor. A medida que se caliente el motor presione la palanca del estrangulador para abrir el estrangulador para una operación normal.

PRECAUCION: Después de conectar el cable del acelerador con la válvula multifuncional del acelerador o después de CADA VEZ que se remueva la válvula multifuncional del acelerador, remueva siempre el filtro de aire y compruebe visualmente que la válvula multifuncional del acelerador cierre completamente y se mueva con libertad en el trayecto.

ESPECIFICACIONES GENERALES DEL CARBURADOR PZ 26	
Boquerel Principal	#96
Boquerel Piloto	(Slow Jet) #37
Aguja del Boquerel	CDB 4th notch
Diámetro del Boquerel Principal	2.6 mm
Giro hacia fuera del Tornillo de Mezcla de Ralentí	1-1/2 1-1/2
Altura del Flotador*	14.0 mm

ESPECIFICACIONES DE TORQUE	
Tornillos Taza	17 - 20 in-lbs
Boquerel Piloto	9 - 12 in-lbs
Boquerel Aguja	14 - 16 in-lbs
Boquerel Principal	9 - 11 in-lbs

MOTOR DE CARRERAS WORLD FORMULA

ESQUEMA ELECTRICO

Este sistema está diseñado para un suministro de energía de 12-voltios. Para la mayoría de aplicaciones de eventos competitivos se recomienda una batería de alta calidad, con celdas de gel (determinada por su cuerpo de aprobación autorizado) con una clasificación de por lo menos 8 amperios hora. Se requiere un cable positivo de batería de 8mm entre la batería y el solenoide de arranque. El suiche de apagado, Parte #557028, apagará el encendido, y se encuentra localizado en la tapa plástica del motor, Parte #555699.

Consulte el esquema del cableado del arranque para las conexiones del suiche de arranque y el cable de la batería.

Esquema del Sistema de Cableado del Arranque Eléctrico

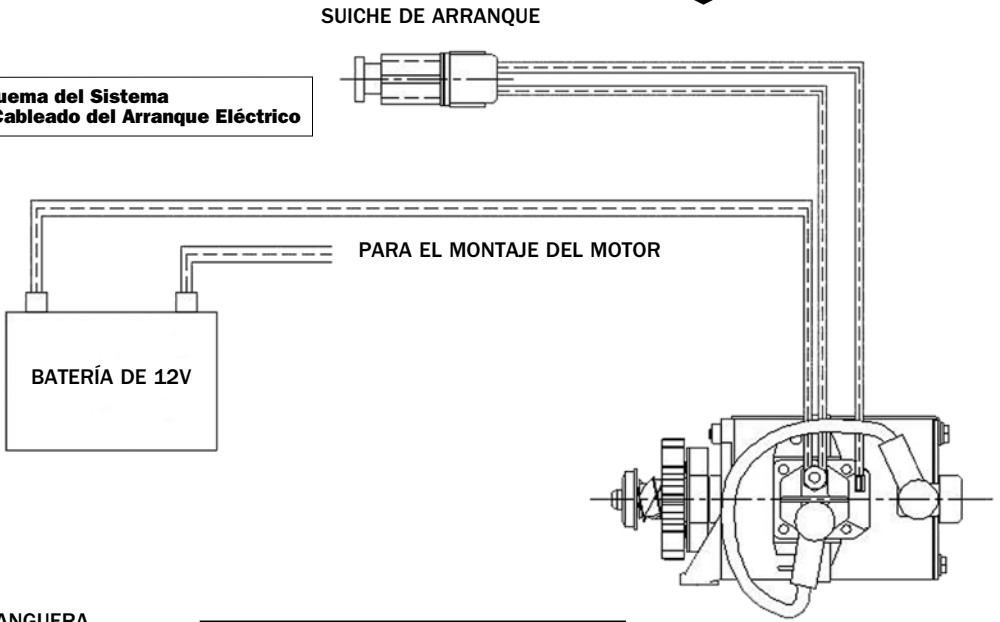

BOMBA DE COMBUSTIBLE

El siguiente diagrama muestra la disposición recomendada para sujetar la bomba de combustible a su motor de carreras World Formula.

Se suministra una bomba de combustible Mikuni. La bomba de combustible debe ser instalada según lo recomendado por su organización local CIK. Recomendamos que esta bomba de combustible sea colocada en una localización que no se vea afectada por el calor. La manguera de pulsación está marcada con una letra "P" en la bomba de combustible. Esta debe ser conectada con una manguera de combustible no plegable (fabricada especialmente para aplicaciones de combustible) al accesorio en la parte superior del múltiple de admisión. Los otros dos aditamentos en la bomba de combustible tienen flechas que muestran la entrada y la salida de la bomba. Por favor refiérase al diagrama que lo acompaña.

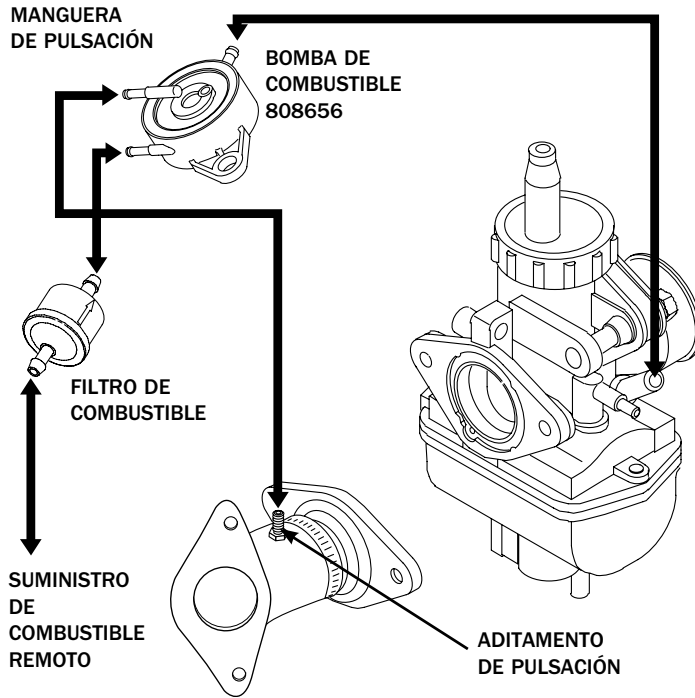

PRECAUCION: RECOMENDAMOS ALTAMENTE USAR UN FILTRO DE COMBUSTIBLE DE 75 MICRONES. ESTE DEBE SER COLOCADO EN LINEA ENTRE EL TANQUE Y LA BOMBA DE COMBUSTIBLE.

SISTEMA DE ESCAPE

El tubo de salida ha sido calibrado y diseñado para funcionar con las siguientes partes:

- A) acople flexible de 50 mm de diámetro x 57 mm de longitud (no incluido)
- B) mofle de "2-tiempos" 50/90 aprobado por CIK (no suministrado)
- C) tres (3) resortes de escape (no suministrados)

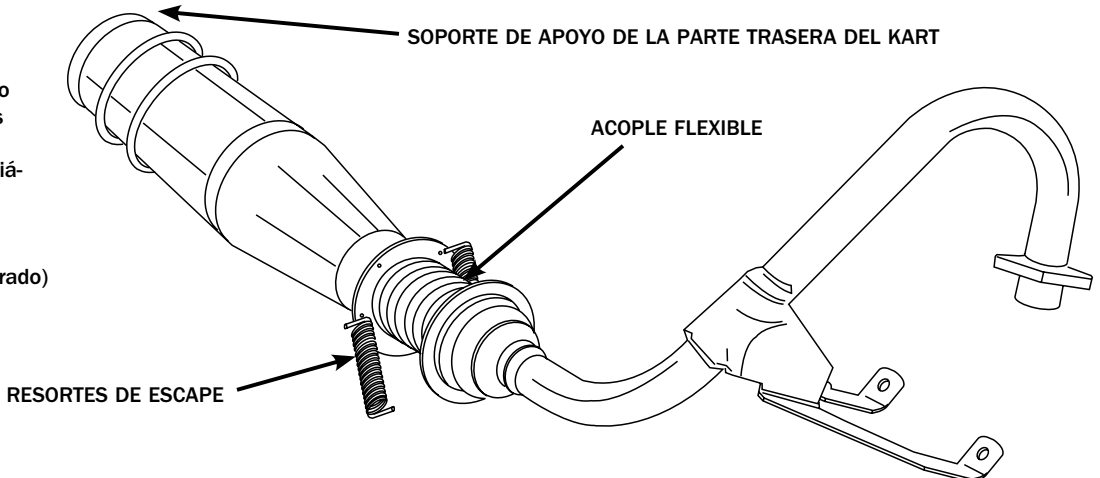

FILTRO DE AIRE VERDE

- Existe una diferencia en tecnología con el filtro de aire de papel estándar y con su nuevo Filtro de Aire Verde de Alto Rendimiento.
- Los filtros de papel atrapan la suciedad por estar compuestos de agujeros pequeños los cuales permiten que pase el aire pero no la suciedad. Desafortunadamente esto es muy restrictivo para su motor. Después de que cada partícula de suciedad queda atrapada el filtro se vuelve mucho más que restrictivo, hasta que el flujo de aire atrapa casi nada, haciendo que su motor le haga falta aire. Esto disminuye drásticamente el desempeño de su motor.
- Para un mejor desempeño se recomienda que su Filtro Verde sea limpiado e impregnado de aceite entre cada competencia.
- El Filtro Verde está compuesto por algodón tejido el cual DEBE ser impregnado de aceite. Un Filtro Verde atrapa la suciedad de manera diferente a un filtro de aire de papel. Los Filtros de Aire Verdes de Alto Rendimiento son diseñados para ser impregnados de aceite. El aceite crea una carga magnética positiva (+) con una malla de acero inoxidable, la cual atrae las partículas de polvo cargadas negativamente (-). El polvo y la suciedad se acumulan alrededor de la malla como formando un túnel. Esto permite al algodón permanecer más limpio para un flujo máximo de aire, y continuar atrapando la suciedad. Este es el por qué es tan importante mantener su Filtro de Aire Verde impregnado de aceite apropiadamente.
- Su Filtro Verde viene pre-impregnado de aceite de fábrica, pero después de cada
- 5-10 horas de competencia se debe revisar el filtro, comprobar que no presente obstrucciones y si es necesario volver a impregnarlo de aceite. (Esto basándose en unas condiciones de competencia normales. Si la competencia es en una pista sucia o en condiciones de mucho polvo se debe limpiar el filtro con mayor frecuencia. Para casos de extrema suciedad limpiar cada 1-2 horas de tiempo de competencia).

Cleaning instructions:

1. Remueva tanta suciedad del filtro como le sea posible golpeándolo ligeramente sobre una superficie dura.
2. Use el Kit de Limpieza y Re-impregnación de Aceite del Filtro Verde (Parte #2000), rocíe el filtro con el limpiador para Filtro Verde. Deje que la solución empape el filtro durante aproximadamente 15 minutos. O diluya el limpiador en un balde con agua y remoje el filtro.
3. PRECAUCION:: Nunca use detergentes fuertes, agua a alta presión ni gasolina..
4. Enjuague el filtro con agua tibia, la parte interna primero y luego la parte externa. (Deje que el agua fluya del lado limpio al lado sucio.)
5. Deje que el filtro se seque completamente. Es mejor dejar que el filtro se seque naturalmente. No utilice calor, ya que este podría encoger el algodón.
6. vuelva a impregnar de aceite el filtro usando UNICAMENTE el aceite del Filtro Verde (kit #2000). No use otros aceites para filtros de algodón, el color es diferente (El aceite verde es de color verde y es especialmente formulado para Filtros Verdes).

* Usted sabrá cuando se ha impregnado correctamente de aceite el filtro si el algodón cambia de blanco a Verde. (parecerá mojado.)

* **PRECAUCION:** Asegúrese de no impregnar demasiado su filtro con aceite, ya que puede ocasionar daños en los sensores y en el motor.

Deje que el filtro se seque durante 1/2 hora. Si usted coloca su Filtro Verde sobre un pedazo de cartón durante 10 minutos y este deja manchas de aceite usted ha impregnado demasiado su filtro con aceite. Límpielo y comience de nuevo.



ADVERTENCIA: Nunca use aceite para motor, fluido para transmisión, WD 40. Dejar de seguir las instrucciones puede causar incendios lo que podría ocasionar la muerte, lesiones corporales o daños a la propiedad.

El Kit para Limpieza y Re-impregnación de Aceite del Filtro Verde es la Parte #2000. Para mayor información y/o preguntas, por favor visite www.greenfilterusa.com

MONTAJE DEL MOTOR

Este motor está diseñado para ser instalado EN POSICIÓN HORIZONTAL en un kart. Debido a la instalación del carburador y al sistema de lubricación, NO recomendamos instalar el motor a un ángulo de cualquier grado.

ACEITE

El aceite es la vida de todo motor y usar uno de buena calidad es un deber! Se recomienda operar con no menos de 18 onzas de aceite sintético grado 30 de clasificación SAE. Es importante que el aceite sea cambiado y monitoreado regularmente ya que la suciedad y otros contaminantes tales como el combustible, etc. afectarán desfavorablemente la vida de este motor.

NOTA: Para el período de despegue de su motor use ÚNICAMENTE un aceite SAE no-sintético grado 30 de alta clasificación. El uso de un aceite sintético durante este proceso podría impedir el “asentamiento” apropiado de los anillos del pistón, etc.

DESPEGUE DEL MOTOR (FUNCIONAMIENTO)

Los primeros 30 minutos de vida de este motor son los más importantes para garantizar una competencia sin problemas. Después de instalar el kart, recomendamos que el motor sea despegado usando cualquier aceite de alto grado no sintético grado 30 de clasificación SAE. Opere el motor sin carga en ralentí (1,700-2,000 rpm) para permitir que el motor alcance la temperatura normal de operación (5-8 minutos). Apague el motor y deje que retorne a la temperatura ambiente. Vuelva a dar arranque al motor y permita que alcance la temperatura de operación (5-8 minutos). Apague el motor y cambie el aceite. Reponga aceite (16-18 onzas) y es el momento de colocar ‘carga’ en el motor. Para aplicar una carga en el motor la forma más fácil para hacerlo es operar el motor en la pista. A una operación no más alta de 6,000 rpm, de varias vueltas (dependiendo de la longitud del recorrido). Con el aceite aún caliente drene y cambie el aceite...repita y comience lentamente a que el motor alcance velocidad.



COMBUSTIBLE

Este motor ha sido diseñado para una bomba de gasolina de 98 Octanos (RON) o 93 Octanos (RON+MON/2). El uso de combustibles de más bajo octanaje podrían ocasionar detonación del motor y/o afectar desfavorablemente la vida de su motor.

MÁXIMAS RPM RECOMENDADAS

Su motor ha sido equipado con un sistema de regulador que limitará las RPM de este motor a alrededor de 7,100 RPM + 50 RPM. Este no eliminará la necesidad de tener un retorno al mecanismo de ralentí. La remoción o la manipulación de este sistema podría conducir a reducir la vida del motor, y/o a ocasionar lesiones graves, incluso la muerte. Tampoco se recomienda el uso repetitivo del limitador de revoluciones como un factor limitativo de RPM. Este limitador de revoluciones trabaja activamente “acortando” el sistema de encendido de su motor. En situaciones repetitivas puede presentarse carga por combustible así como también un incremento en la carga de presión interna del motor, reduciendo enormemente la vida del motor.

LIMITADOR DE REVOLUCIONES – PARTE #557125

ADVERTENCIA

No desconecte ni modifique el limitador de revoluciones instalado. El exceso de velocidad en el motor puede dar lugar a una falla en la volante o en otra parte y ocasionar la muerte, lesiones graves o daños a la propiedad.

CARBURATEUR WALBRO PZ

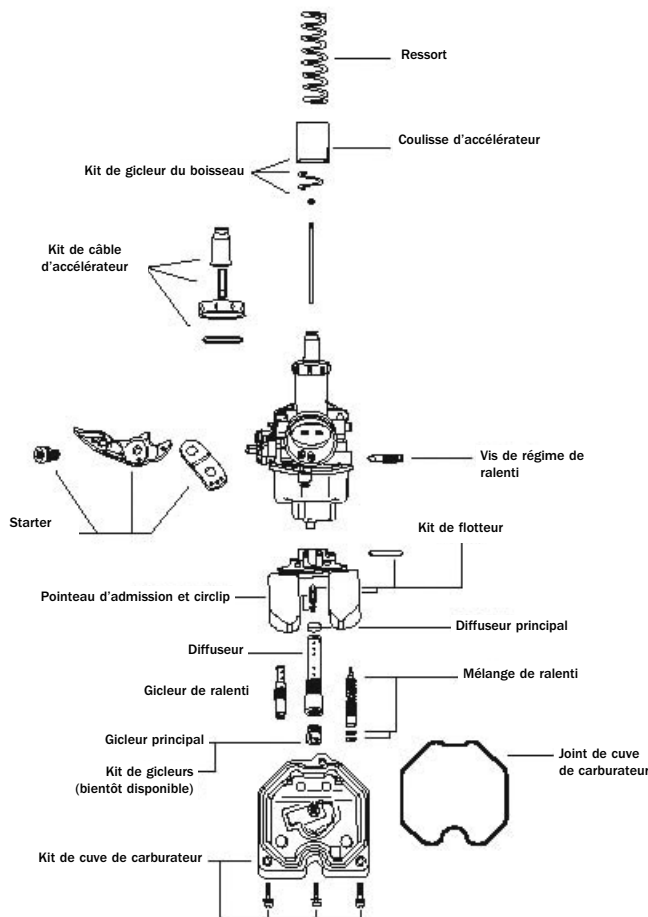

Carburateur Walbro PZ

Le carburateur Walbro PZ 26 a été spécialement calibré pour cette utilisation. Le guide suivant doit vous aider pour les réglages et l'entretien. Les pièces de rechange sont disponibles auprès de votre fournisseur autorisé. Un jeu de gicleurs supplémentaires est aussi disponible sous la réf. 557012 - Ce kit a été spécialement conçu pour couvrir la majorité des besoins de gicleurs à essence.

Hauteur du flotteur

La hauteur du flotteur détermine le niveau de carburant dans la cuve, ce qui influe sur les performances du carburateur. Régler la hauteur du flotteur selon les spécifications avant d'entreprendre tout autre réglage.

Ralenti, basse vitesse

Le réglage du moteur au ralenti et à basse vitesse se fait en réglant la vis de mélange de ralenti ou en changeant la taille du gicleur de ralenti. La taille du gicleur ou son diamètre en millimètres est marqué sur le gicleur (38 = trou de 0,38 mm). La vis de mélange de ralenti règle la quantité de carburant de la façon suivante : fermer la vis (la tourner dans le sens horaire) appauvrit le mélange et l'ouvrir (la tourner dans le sens contraire) enrichit le mélange.

Pour régler la vis de mélange de ralenti, procéder comme suit. Fermer la vis de mélange jusqu'à ce qu'elle bute légèrement ou qu'elle ne puisse plus tourner. Dévisser la vis du nombre de tours

spécifié. Faire chauffer le moteur et régler la vis pour que le régime de ralenti soit un peu plus élevé que celui que vous voulez obtenir. Un mélange légèrement trop riche donne normalement de meilleures accélérations.

S'il n'est pas possible d'obtenir un ralenti correct quand la vis de mélange est dévissée entre 1/4 et 2 tours depuis sa position fermée, il faut changer la taille du gicleur de ralenti. Un bon gicleur de ralenti permet une accélération progressive depuis le ralenti jusqu'à un régime stabilisé du moteur correspondant à 1/4 de l'ouverture de l'accélérateur.

Régime intermédiaire, accélérateur en partie ouvert

L'aiguille du boisseau contrôle principalement le débit de carburant entre 1/4 et 3/4 d'ouverture de l'accélérateur. Cette aiguille dispose de cinq encoches et d'une agrafe en C à son extrémité supérieure. Pour enrichir le mélange quand l'accélérateur est partiellement ouvert, déplacer l'agrafe pour la mettre sur l'encoche suivante vers le bas. Cela éloigne l'aiguille du diffuseur. Pour appauvrir le mélange quand l'accélérateur est partiellement ouvert, déplacer l'agrafe sur l'encoche suivante vers le haut. L'encoche la plus haute (la plus éloignée de la pointe) est la 1^{ère} position. L'identification du cône de l'aiguille se fait grâce aux lettres de référence de l'angle se fait grâce aux lettres de référence de l'angle de la pointe.

Haut régime, accélérateur à fond

Le gicleur principal contrôle le débit de carburant pour une position d'accélérateur entre ouverture à 1/2 et accélérateur à fond. La taille du gicleur ou son diamètre en millimètres est marqué sur le gicleur. L'altitude et les conditions climatiques peuvent suffisamment influencer sur le fonctionnement du moteur pour nécessiter un changement de taille du gicleur principal. Une température élevée, l'humidité ou l'altitude peuvent nécessiter un gicleur principal plus petit. Une température basse, l'humidité ou l'altitude peuvent nécessiter un gicleur principal de plus grand diamètre.

DÉMARRAGE

Ce carburateur est équipé d'un starter pour le démarrage. Quand le moteur est froid, tirer le starter pour le démarrer. Au fur et à mesure du réchauffement du moteur, repousser le starter jusqu'au bout pour un fonctionnement normal.

ATTENTION: Après avoir raccordé le câble d'accélérateur à la guillotine d'accélération ou **CHAQUE FOIS** que la guillotine est démontée, déposer le filtre à air et vérifier visuellement que la guillotine se ferme complètement et se déplace sans frottement dans ses coulisses.

COUPLES DE SERRAGE	
Gicleur principal	#96
Gicleur de ralenti	(Slow Jet) #37
Gicleur du boisseau	CDB 4th notch
Diamètre du gicleur principal	2.6 mm
Nombre de tours pour dévisser la vis de mélange de ralenti	1 à 1/2 1-1/2
Hauteur du flotteur*	14.0 mm

TORQUE SPECIFICATIONS	
Vis de la cuve	17 - 20 in-lbs
Gicleur de ralenti	9 - 12 in-lbs
Gicleur du boisseau	14 - 16 in-lbs
Gicleur principal	9 - 11 in-lbs

SCHÉMA ÉLECTRIQUE

Ce système est conçu pour fonctionner à partir d'une source électrique de 12 volts. Pour la plupart des utilisations en compétition, nous recommandons d'utiliser une batterie à gel d'acide, (définie par l'autorité de vérification) d'au moins 8 Ah de capacité. Un câble positif de batterie de 8 mm² est nécessaire pour raccorder la batterie au démarreur. Le contacteur à bascule, Réf. 557028, situé sur le capot moteur en plastique, Réf. 555699, permet de couper le contact.

Voir le contacteur de démarrage et les raccords de la batterie dans le schéma de câblage du démarreur.

Schéma de câblage du démarreur électrique

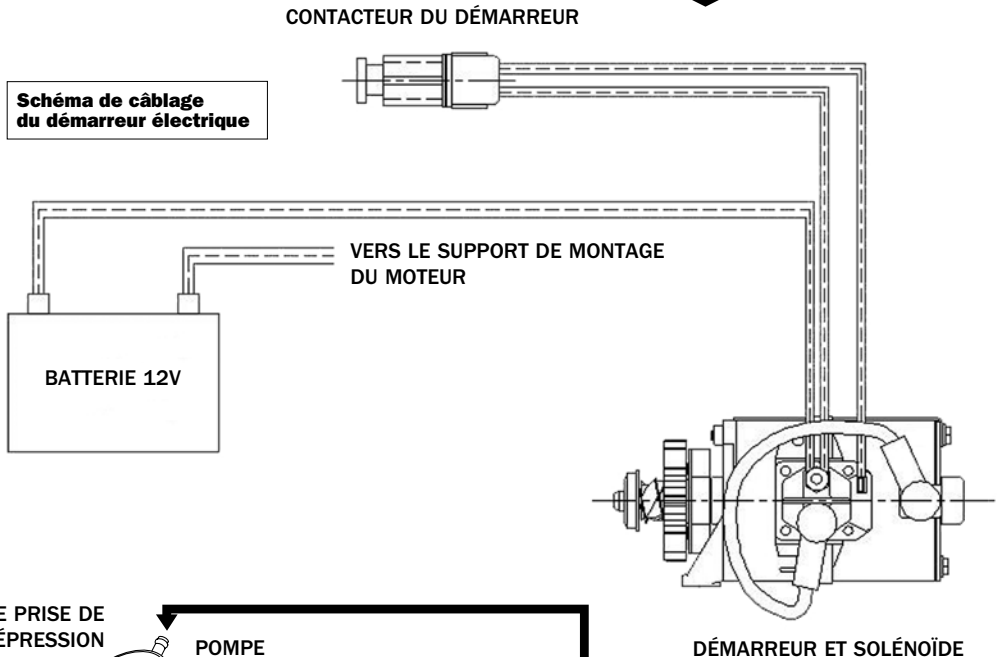

POMPE D'ALIMENTATION

Le schéma suivant donne la disposition recommandée pour raccorder la pompe à essence au moteur de course World Formula. Une pompe à essence Mikuni est fournie avec le moteur. La pompe doit être installée selon les recommandations de votre organisation CIK locale. Nous recommandons de placer cette pompe à essence à un endroit où elle ne sera pas affectée par la chaleur. La ligne de refoulement est indiquée par un P sur la pompe. Cette sortie doit être raccordée par une Durit (spécialement fabriquée pour utilisation avec de l'essence) au raccord sur le dessus du collecteur d'admission. Les deux autres raccords de la pompe ont des flèches qui indiquent l'entrée et la sortie de la pompe. Veuillez vous référer au schéma joint.

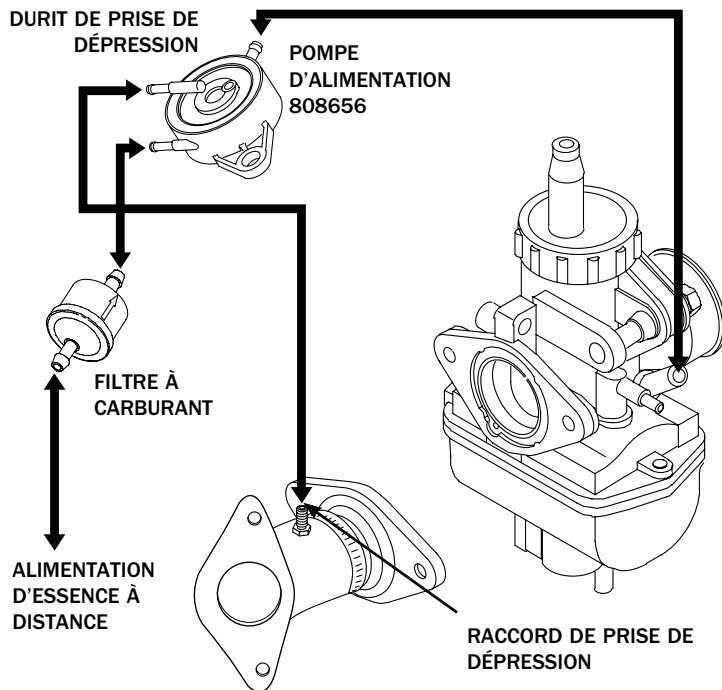

ATTENTION: NOUS RECOMMANDONS FORTEMENT D'UTILISER UN FILTRE À ESSENCE DE 75 MICRONS ET DE LE METTRE EN LIGNE ENTRE LE RÉSERVOIR ET LA POMPE À ESSENCE.

SYSTÈME D'ÉCHAPPEMENT

Le tuyau du collecteur a été conçu et mis au point pour fonctionner avec les pièces suivantes:

- Un raccord flexible de 50 mm de diamètre et 57 mm de long (non fourni)
- Un silencieux « 2 temps » de 50/90 approuvé par la CIK (non fourni)
- Trois (3) ressorts d'échappement (non fournis)

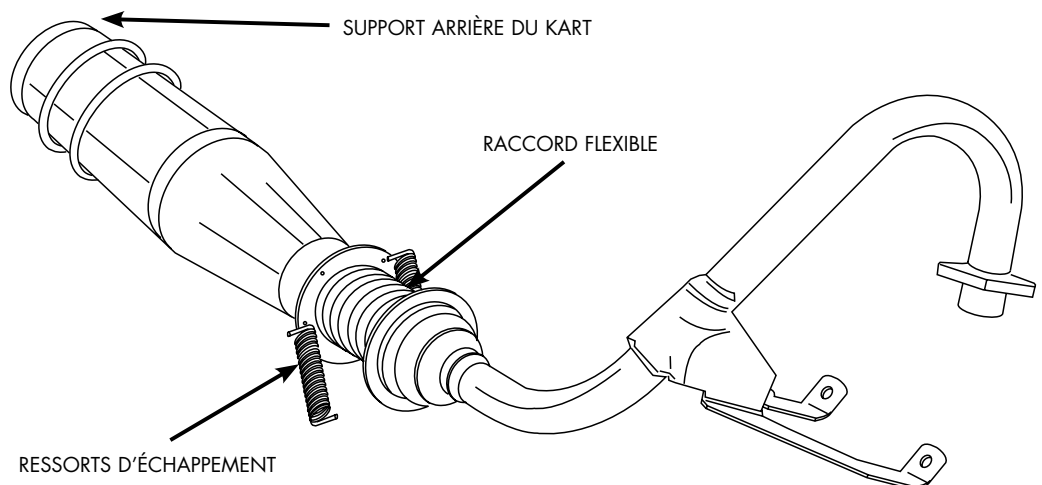

LES FILTRES VERTS

- Il y a une grande différence de technique entre un filtre à air standard en papier et votre nouveau Filtre Vert haute performance.
- Les petits trous des filtres en papier arrêtent la poussière et laissent passer l'air. Malheureusement, ils restreignent beaucoup les capacités du moteur. Chaque particule de poussière arrêtée bouche un peu plus le filtre jusqu'à ce que le débit d'air devienne très faible, empêchant le moteur de respirer. Ceci réduit considérablement les performances du moteur.
- Pour conserver les performances au meilleur niveau, il est recommandé de nettoyer et d'huiler le Filtre Vert entre chaque course.
- Le Filtre Vert est fait de coton tissé qui DOIT être huilé. Il n'arrête pas la poussière comme un filtre en papier. Les Filtres Verts haute performance sont conçus pour être huilés. L'huile crée une charge magnétique positive (+) avec la grille en acier inoxydable qui attire les particules de poussière chargées négativement (-). La poussière et la saleté se concentrent autour de la grille pour former un tunnel. Cela permet au coton de rester plus propre et de laisser passer un débit d'air maximum, tout en arrêtant la poussière. C'est pourquoi il est important de toujours huiler correctement le Filtre Vert.
- Votre Filtre Vert a été huilé en usine, mais il faut vérifier son encrassement toutes les 5 à 10 heures de course et l'huiler de nouveau. (Cela tient compte des conditions normales de course. Lorsque l'on court sur terre ou dans des conditions poussiéreuses, il faut nettoyer le filtre plus souvent. Dans les cas extrêmes, il faut le nettoyer toutes les 1 à 2 heures de course).

Instructions de nettoyage :

1. Retirer autant de poussière que possible en tapant le filtre sur une surface dure.
 2. Avec le kit de nettoyage et d'huilage du Filtre Vert (Réf. 2000), vaporiser le filtre de nettoyant. Laisser la solution s'imprégner dans le filtre pendant 15 minutes environ. Ou diluer le nettoyant dans un baquet d'eau et laisser tremper.
 3. ATTENTION: Ne jamais utiliser de détergent puissant, d'eau sous pression ni d'essence.
 4. Rincer le filtre à l'eau chaude, de l'intérieur vers l'extérieur. (Laisser l'eau couler du côté propre vers le côté sale.)
 5. 4. Laisser le filtre sécher complètement. Il vaut mieux le laisser sécher naturellement. Ne pas le chauffer, cela pourrait faire rétrécir le coton.
 6. 5. Huiler le filtre UNIQUEMENT avec l'huile pour Filtre Vert (kit Réf. 2000). Ne pas utiliser d'autres huiles pour filtre en coton, la couleur est différente (L'huile verte est colorée en vert et est spécialement formulée pour les Filtres Verts).
- * Un filtre est correctement huilé lorsque le coton blanc prend une couleur verte (le filtre paraît humide)
- * **ATTENTION: S'assurer de ne pas mettre trop d'huile sur le filtre, cela peut endommager les capteurs et le moteur.**

Laisser le filtre sécher pendant 1/2 heure. Si on laisse le Filtre Vert sur un morceau de carton pendant 10 minutes et qu'il y a des taches d'huile, c'est qu'il est trop huilé. Le nettoyer et recommencer.



AVERTISSEMENT : Ne jamais utiliser de l'huile de transmission, WD 40. Le fait de ne pas respecter les instructions peut entraîner un incendie qui peut provoquer la mort, des blessures corporelles ou des dégâts matériels.

La référence du kit de nettoyage et d'huilage du Filtre Vert est 2000. Pour obtenir plus d'informations et les réponses à vos questions, visiter le site : www.greenfilterusa.com.

MONTAGE DU MOTEUR

Ce moteur a été conçu pour être monté à PLAT dans le kart. En raison des réglages et du système de graissage du carburateur, nous NE recommandons PAS de monter le moteur selon un angle quelconque.

 **HUILE**

L'huile est la survie de tout moteur et il est absolument nécessaire d'utiliser une huile de bonne qualité. Nous recommandons d'utiliser au moins 0,5 l (18 onces) d'huile synthétique SEA 30. Il est important de changer et de surveiller l'huile de façon régulière car la poussière et d'autres contaminations (essence, etc.) affectent la durée de vie de ce moteur.

NOTE : Pendant le rodage du moteur, n'utiliser QUE de l'huile non synthétique SAE 30 de bonne qualité. L'utilisation d'une huile synthétique pendant le rodage pourrait empêcher le bon « rodage » des segments, etc.

RODAGE DU MOTEUR

Les trente premières minutes de la vie de ce moteur sont les plus importantes pour son avenir en course. Après l'avoir monté sur le kart, nous recommandons de roder le moteur avec une huile non synthétique SAE 30 de bonne qualité. Faire tourner le moteur, à vide, au ralenti (1 700 à 2 000 tr / mn) et le laisser atteindre sa température normale de fonctionnement (5 à 8 minutes). Arrêter le moteur et le laisser refroidir à la température ambiante.

Le démarrer de nouveau et l'amener à sa température de fonctionnement (5 à 8 minutes). L'arrêter et changer l'huile. Remplir d'huile neuve 0,5 à 0,6 l (16 à 18 onces) et commencer à le mettre en « charge ». Pour le mettre en charge, la meilleure solution est de l'utiliser sur la piste. Ne pas le faire tourner à plus de 6 000 tr / mn, faire plusieurs tours (selon la longueur de la piste). Pendant que le moteur est encore chaud, vidanger et remplacer l'huile. Recommencer et commencer lentement à monter les régimes.

 **ESSENCE**

Ce moteur a été conçu pour fonctionner avec de l'essence du commerce à 98 Octane (RON) ou 93 Octane RON+MON/2). L'utilisation d'un indice d'octane plus faible peut entraîner une détérioration du moteur et influencer sur la durée de vie du moteur.

RÉGIME MAXIMUM RECOMMANDÉ

Ce moteur est équipé d'un système de régulateur qui limite le régime à environ 7 100 tr/min + 50 tr/min. Cela n'empêche pas d'avoir un mécanisme de retour au ralenti. La dépose ou une modification de ce système peut réduire la durée de vie du moteur et un risque de blessure grave, voire même la mort. Nous ne recommandons donc pas d'utiliser en permanence le limiteur de régime comme moyen d'atteindre le régime maximum. Ce limiteur de régime fonctionne en « coupant » le système d'allumage du moteur. L'utilisation répétitive à plein gaz ainsi que des tensions internes, accroissent la charge du moteur et réduisent fortement sa durée de vie.

LIMITEUR DE RÉGIME, RÉF. #557125 **ATTENTION**

Ne pas débrancher ni modifier le limiteur de régime installé. Un surrégime peut entraîner une défaillance du volant moteur ou d'autres pièces, entraînant la mort, des blessures graves ou des dégâts matériels.

Log Book

DATE	WORK PERFORMED	SEAL NUMBER	WORK PERFORMED BY
1/31/08	<i>example: Replaced Air Cleaner</i>		DK







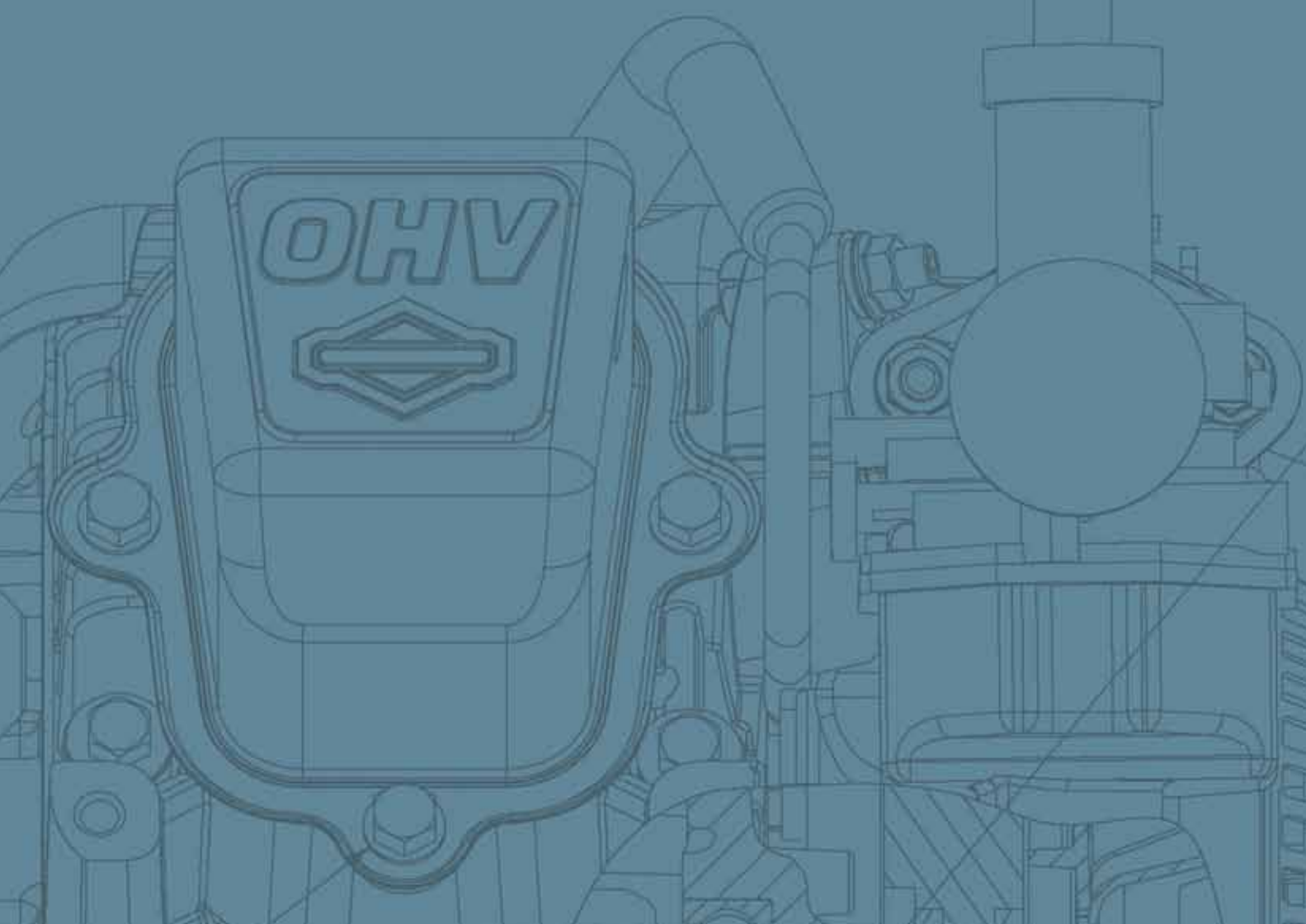

BRIGGSRACING.com



MS5702 (REV. B)

BRIGGS&STRATTON
CORPORATION

POST OFFICE BOX 702
MILWAUKEE, WI 53201 USA
414 259 5333

©2012 Briggs & Stratton Corporation



THE POWER WITHIN™